

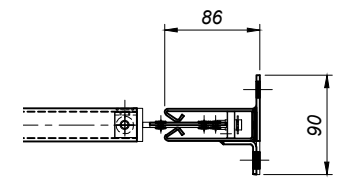

Section B - B

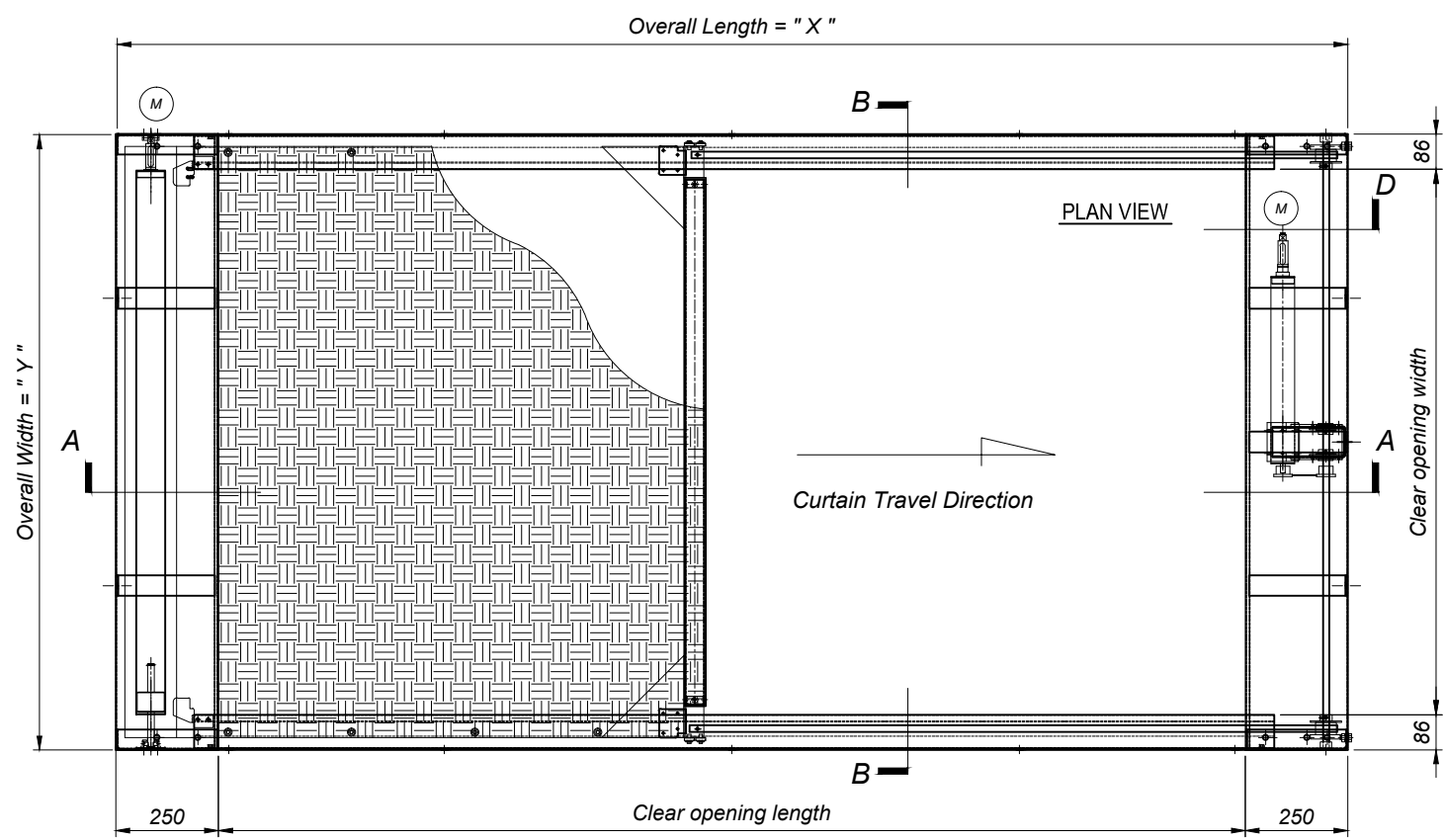

Section C
Side Guide Detail

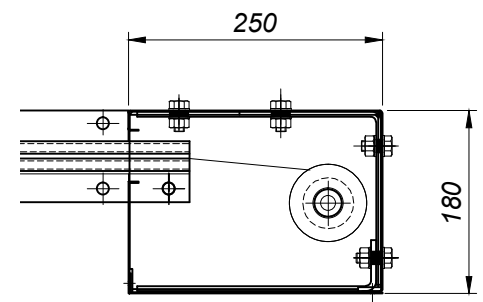

Section D
Pulley System

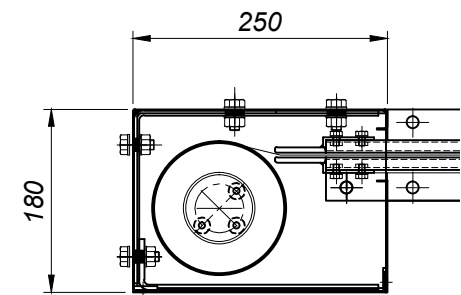

1 Headbox Roller
Assembly End Detail

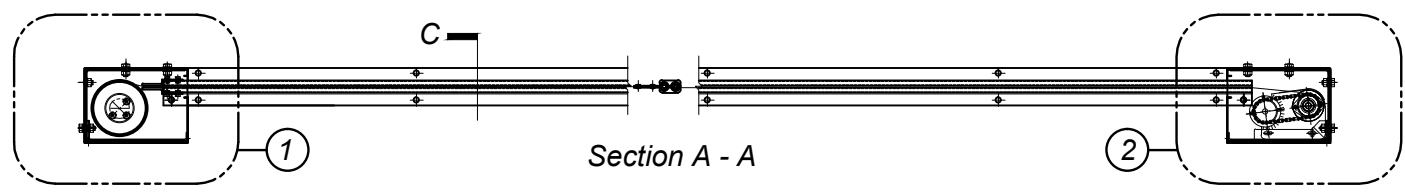

Section A - A

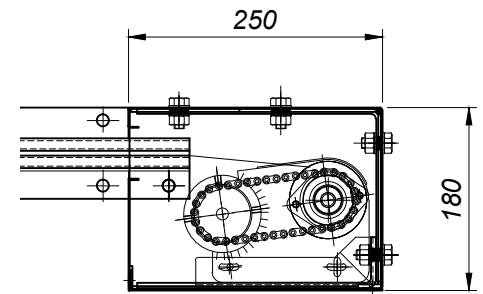

2 Headbox Pulley
Assembly End Detail

NOTE:
 - See Drawing HRZ/MIN/20 for installation Criteria
 - This drawing should be considered as a guide only, as some details have been omitted for clarity

SIZE OUTSIDE STATED STANDARDS - PLEASE CONTACT COOPERS FIRE LTD

 <p>Edward House, Penner Road, Havant, Hampshire, PO9 1QZ, UK</p> <p>Tel: +44 (0) 23 9245 4405 Fax: +44 (0) 23 9249 2732 Email: info@coopersfire.com Web: www.coopersfire.com</p>	DRAWN:	TITLE:	
	ML	FIREMASTER® MINI SIMPLEX™ HORIZONTAL FIRE CURTAIN TYPICAL ARRANGEMENT	
	CHECKED:	<small>© 1997 A COOPER GROUP LIMITED ALL RIGHTS RESERVED. THIS DESIGN MAY NOT BE REPRODUCED IN ANY MATERIAL FORM INCLUDING ELECTRONICALLY WITHOUT THE WRITTEN PERMISSION OF THE COPYRIGHT NAMES</small>	ALL DIMENSION IN MILLIMETERS UNLESS OTHERWISE STATED
	APPROVED:	DRG. No.	ISSUE:
JR	HRZ/MIN/21	G	
		DATE:	27.03.2015

MINIMUM SIZE
 "X" = 1 METRES
 "Y" = 1 METRES
 MAXIMUM SIZE
 "X" = 7 METRES
 "Y" = 2.5 METRES